

STROMER

POWER

Comprehensive Specification Sheet

Low-Voltage AC Alternator
Electrical and Mechanical Data



STRO-70K

63 kVA Prime / 70 kVA Standby
Three Phase / 50Hz / 4 pole

WORLD CLASS ALTERNATORS

StromerPower is a global leader for quality alternators from 10kVA to 1100kVA
We provide alternators for generator set manufacturers and power producers worldwide

Every day, our products help secure access to power for thousands of people

We offer solutions for all standby and prime applications, from industrial outposts and mines to busy commercial zones and even residential neighborhoods

StromerPower alternators are available globally through a network of trusted distributors who adhere to our stringent quality controls and share our commitment to quality, reliability and trust



STANDARDS QUALITY AND PRECISION

StromerPower alternators meet all key international standards and regulations
Our alternators comply with the following major domestic and international standards and regulations
GB755, BS5000, IEC60034, VDE0530, CSAC22.2 100, NEMA MG-1.22
Designed, manufactured and marketed in an **ISO 9001** quality assurance environment
our alternators can be integrated in CE-marked generator set

ABOUT THE FACTORY BUILT ON LEGACY

Our factory has been providing world-class alternators and power generation solutions since 1955 with the vision of becoming a leading manufacturer of world-class alternator products.

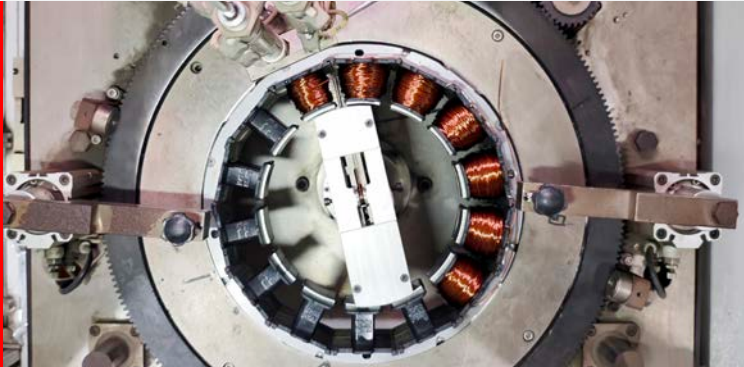

**FACTORY
STATISTICS**

+60
years of experience

+30,000
square meter workshop

ISO 9001
quality rated

STRO-70K

Three Phase / 63 kVA Prime / 70 kVA Standby / 50Hz / 4 pole

Dimensions

Unpacked				Packed			
Length	Width	Height	Net Weight	Length	Width	Height	Gross Weight
mm			kg	mm			kg
695	500	546	241	780	580	730	270

Specifications Overview

Single Phase / 50Hz / 400V / PF = 1			
Continuous 40 °C		Standby 40 °C	
kw	kVA	kw	kVA
50	63	56	70

Rated Frequency	Voltage	Voltage Regulation	Voltage Regulation Change	Phase Change Rate	Power Factor
Hz	v	v	% UN	%	
50	400	+/- 1%	< +/- 10	+/- 1	0.8

Insulation Class	Type	Phase and Connection	
H	IM B35	Single Phase	Series Star

AVR Model	Stator	Rotor
SX460	2/3 Pitch	Single Bearing



SAE Rating

Model	LB	LC	Xg	kg
	SAE			
STRO-70K	636	348	299	253

Adapter

SAE	BX	AM	AR - øAS	AH
	mm			
#3/11.5"	241.3	222.25	8 - ø11	39.6

Flange

SAE	P	N	M	R - øS	W	D	a°
	mm						
#3/11.5"	460	409.575	428.625	12 - ø12	6.5	203.5	15

STRO-70K

Three Phase / 63 kVA Prime / 70 kVA Standby / 50Hz / 4 pole

Mechanical Construction

- StromerPower enclosures are IP23
- All rotors are dynamically balanced in strict accordance with the requirements of the ISO1940 standard
- Robust flanges and shields
- The large junction box makes wiring and adjustment of the AVR easier
- Space for current transformers or other optional modules to be installed
- Compact design and sturdy assembly to withstand generator vibrations
- All our alternators use long-term sealed bearings
- Steel base

Excitation System Regulations

- **Parallel Use:** When the appropriate modules (AVR, current transformer and control equipment) are installed, all 2-pole alternators can be used in parallel
- **Bearing Capacity:** NEMA specifications
- **Waveform:** According to the IEC standard, the total harmonic distortion rate is less than 5% under no-load or non-linear load. The telephone interference factor (TIF) is less than 50 in accordance with NEMA specifications
- **Frequency:** To be used at a frequency of 50Hz (standard windings) (No. B31, B32)
- **Power Factor:** The alternator is designed for loads with a power factor of 1

Single-Bearing Outline Schematic

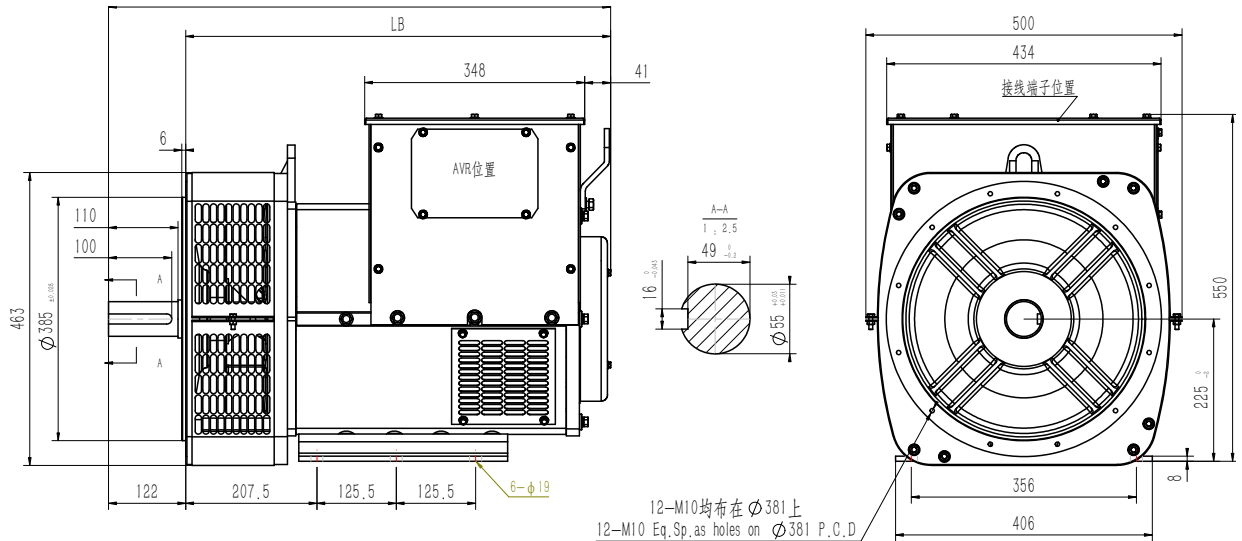

Fan		Main Rotor		Excitation Rotor		Shaft		Total	
Weight (kg)	J(kgm ²)	Weight (kg)	J(kgm ²)	Weight (kg)	J(kgm ²)	Weight (kg)	J(kgm ²)	Weight (kg)	J(kgm ²)
1.112	0.017	50.9	0.371	11.1	0.274	18.5	0.0111	81.612	0.6731

SAE	5	Shafts Coupling Flex Plate		
	D	L	Weight (kg)	J(kgm ²)
#3/11.5"	207.5	636	2.29	0.0357

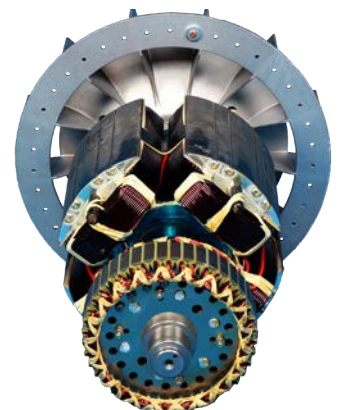

STROMER

POWER

Stromer Power Low-Voltage AC Alternator -STRO-70K